

NG-EPON

Industry Connections (IC)

Marek Hajduczenia, Acting Chair

Bright House Networks

Louisville, CO, USA, 02/02/2015

NG-EPON IC Structure

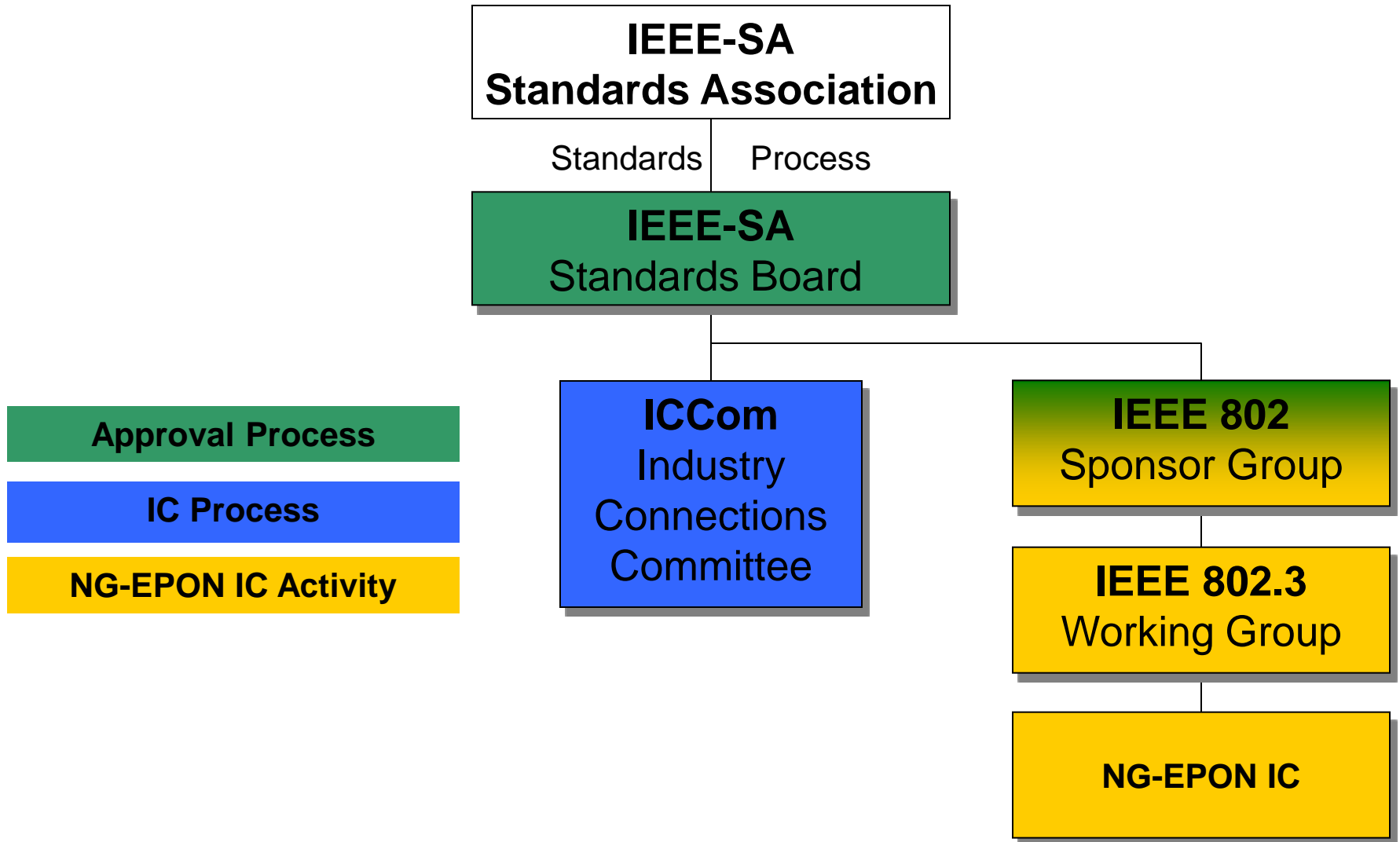

NG-EPON ICAID

- NG-EPON IC Activity Initiation Document (ICAID) can be found at: [NGEPON ICAID](#)
- Expected completion of NG-EPON IC activities in December'15
- Deliverables of NG-EPON IC: report to be published as 802.3 WG communication, following a liaison approval process
- Participation open to all individuals

NG-EPON IC project goals

- Create a venue for interested individuals to discuss the requirements and technical options for the next generation of Ethernet Passive Optical Networks
- Operate under and report to the IEEE 802.3 Ethernet Working Group
- Explore operators' requirements
- Explore market potential
- Explore technological and economic tradeoffs.
- Explore the state of the art of optical technology for subscriber access networks
- Produce a report of the group's findings

NG-EPON IC status

- 9 meetings of NG-EPON IC held so far
- NG-EPON report D1.0 (draft) published in January'15. NG-EPON draft D2.0 expected mid February'15.
- Main focus on completion of the NG-EPON IC report to seek 802.3 WG approval in March'15 plenary
- Call For Internet (CFI) expected within the next few months. Details to be distributed on NG-EPON reflector.

NG-EPON IC report (1)

- Draft report D1.0 is available for preview within the private area of the NG-EPON IC ad-hoc ([private area](#))
- Draft focuses on project goals, exploring operators' requirements, market potential, technological and economic tradeoffs, as well as the state of the art of optical technology for subscriber access networks
- Outline is presented on the next slide

NG-EPON IC report (2)

- NG-EPON IC report outline

1	INTRODUCTION.....	1
2	ABBREVIATIONS.....	1
3	TAXONOMY OF PON-BASED ACCESS NETWORK TECHNOLOGIES	1
4	MOTIVATION FOR NG-EPON.....	9
5	REQUIREMENTS FOR NG-EPON	22
6	TECHNICAL FEASIBILITY OF NG-EPON	38
7	ECONOMIC FEASIBILITY OF NG-EPON	70
8	CONCLUSIONS	73
9	CITATIONS.....	74

NG-EPON IC report (3)

- Different architectures are possible

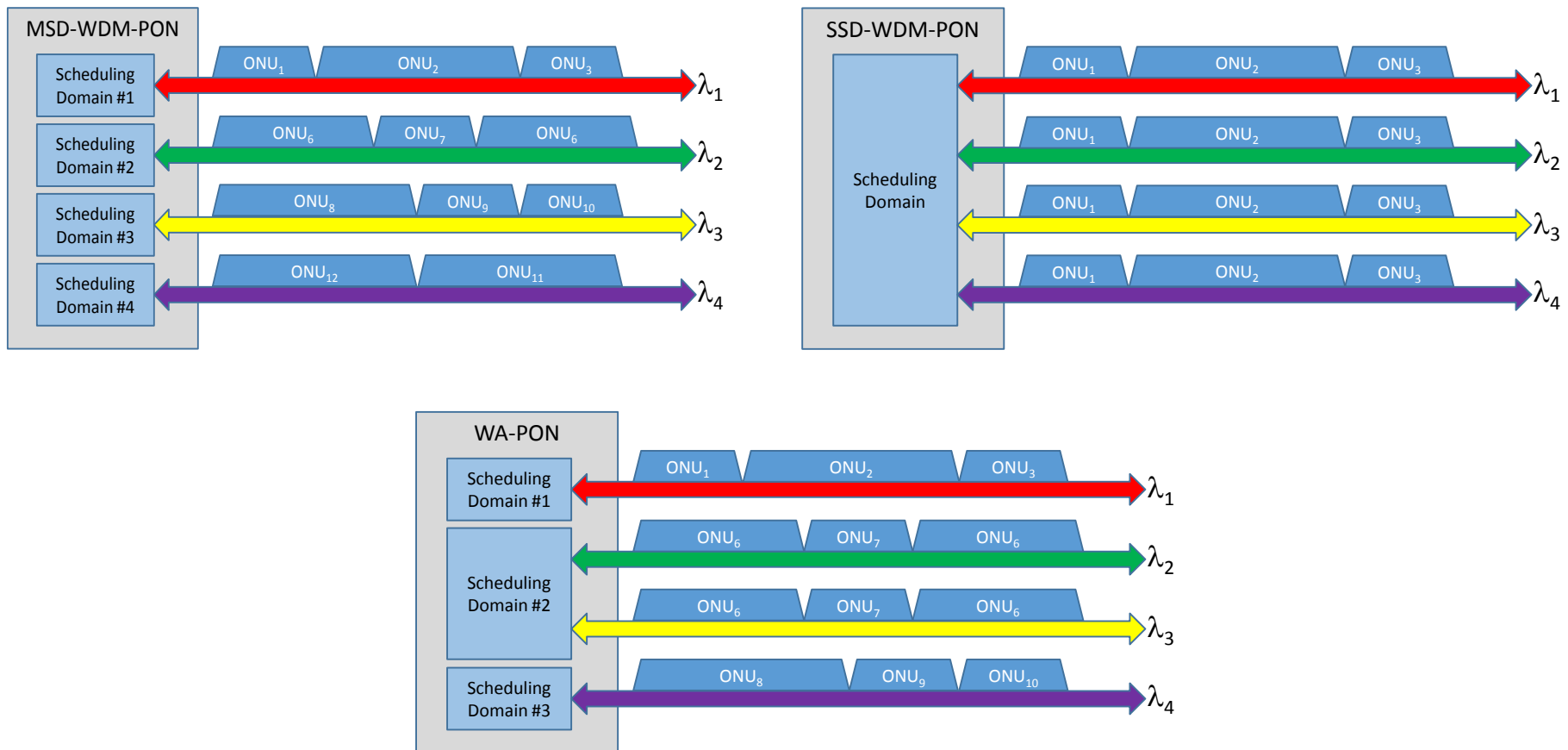

NG-EPON IC report (4)

- Examples of bandwidth consumption trends

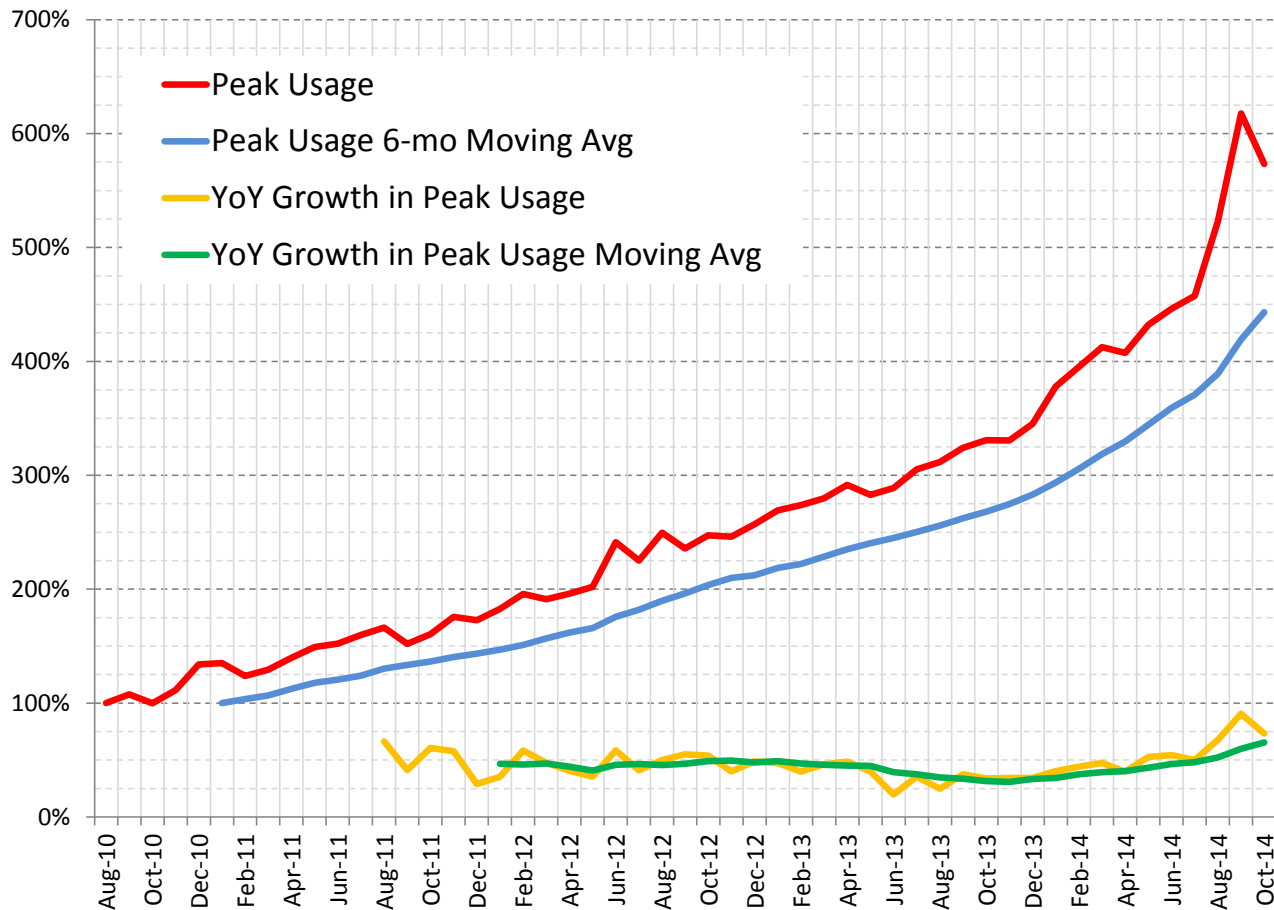

NG-EPON IC report (5)

- Service examples

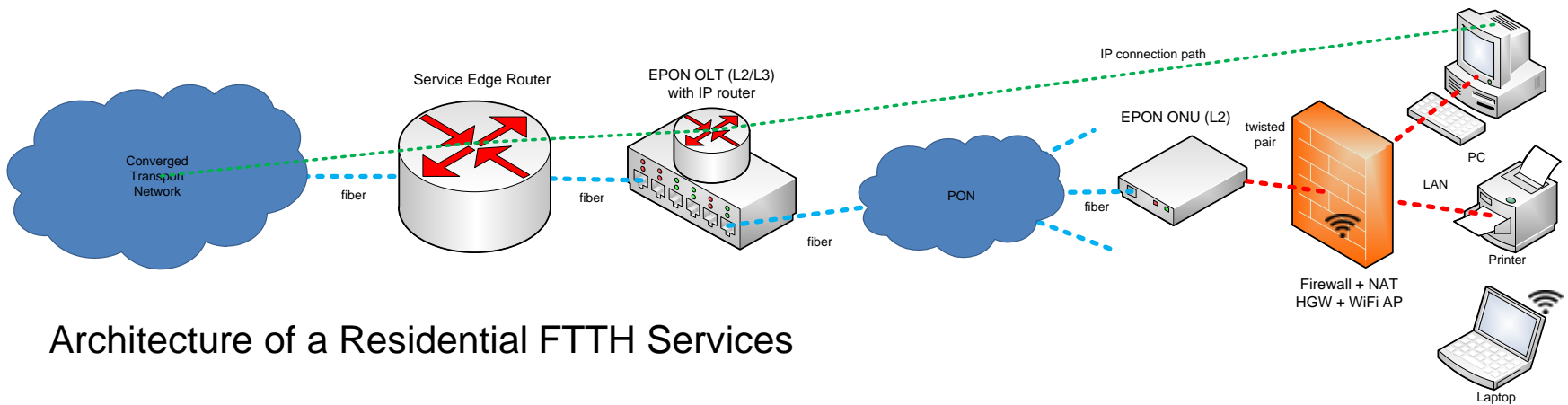

Architecture of a Residential FTTH Services

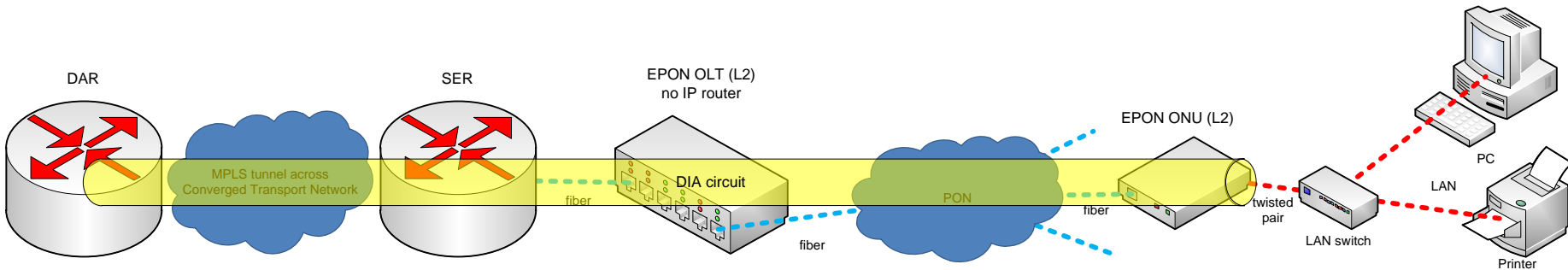

Architecture of DIA service

NG-EPON IC report (6)

- Service examples

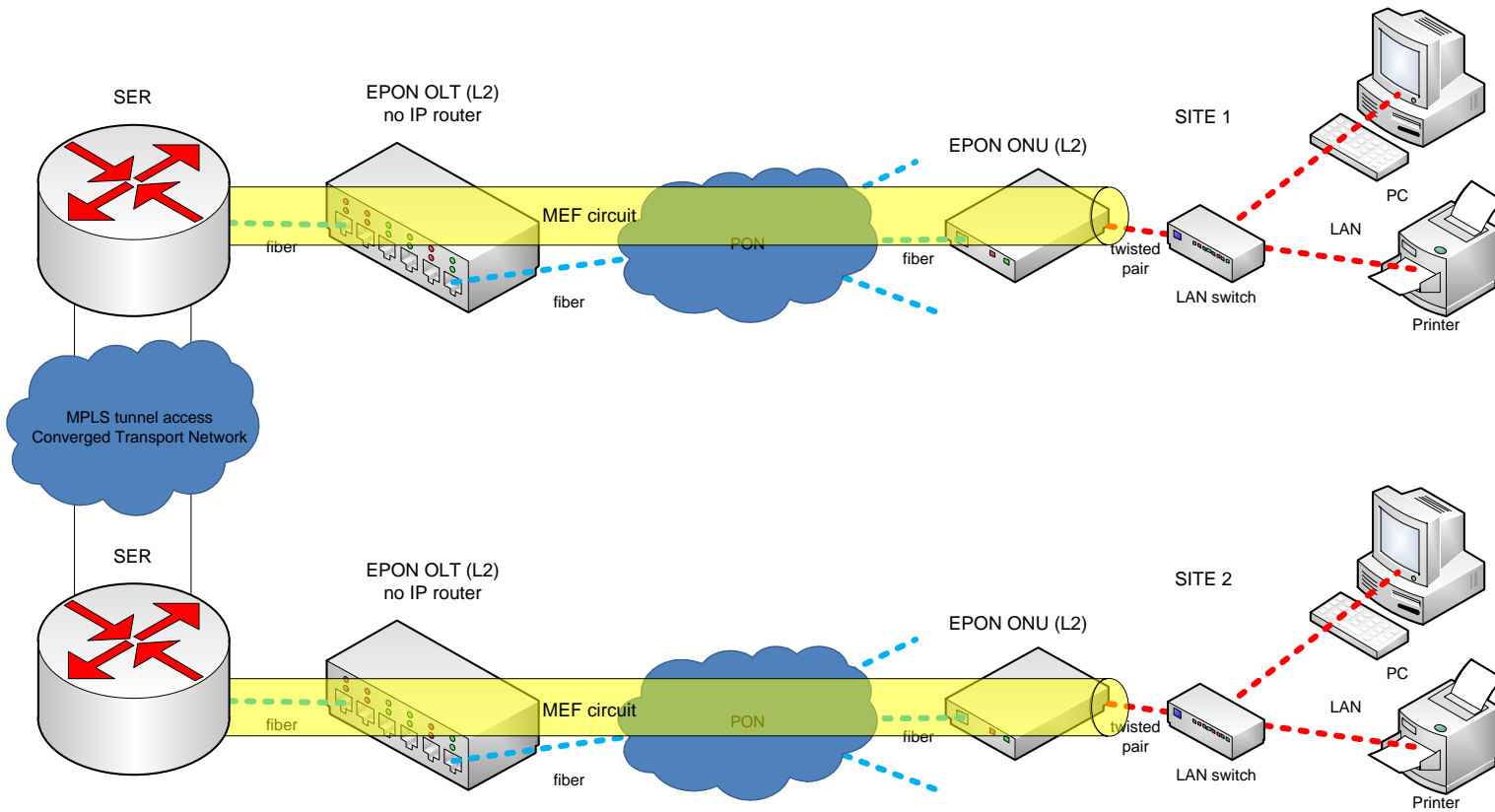

Architecture of MEF Services

NG-EPON IC report (7)

- Service examples

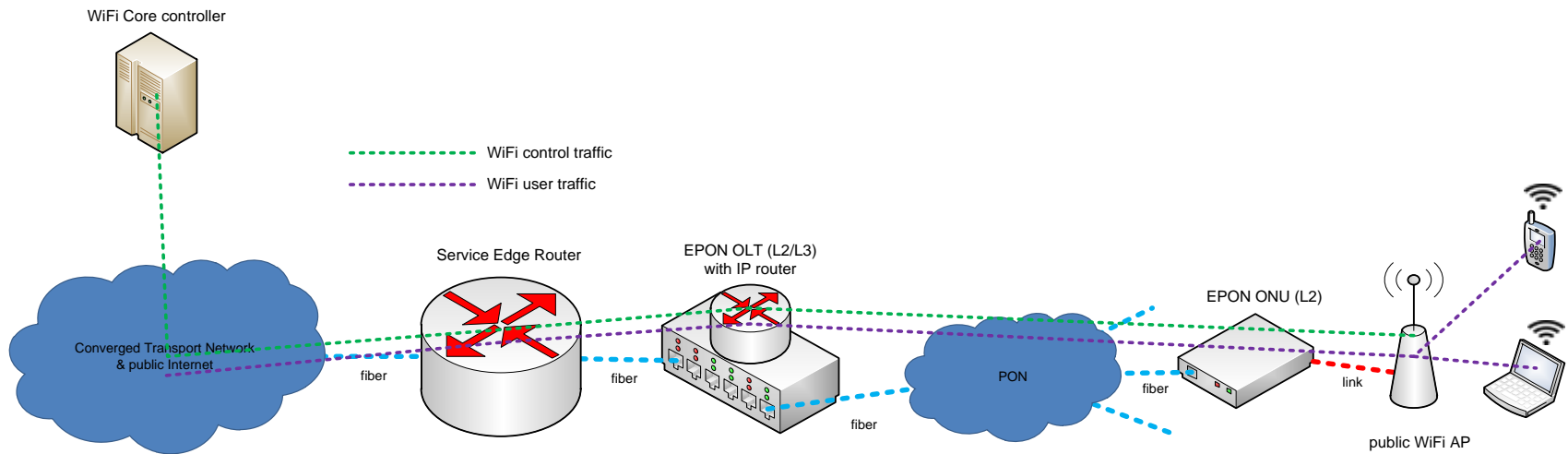

Architecture of Public WiFi Backhaul Service

Next Steps

- Publish report draft D2.0 and send out for comments to NG-EPON IC ad-hoc and 802.3 WG membership
- Resolution of received comments during plenary meeting in March'15
- Seek 802.3 WG approval of report at the closing plenary in March'15
- Report gets published after professional preparation by IEEE-SA editors.

Reflector and Web

- NG-EPON IC Ad-hoc home page URL:
http://www.ieee802.org/3/ad_hoc/ngepon/
- NG-EPON IC email reflector subscription:
http://www.ieee802.org/3/ad_hoc/ngepon/reflector.html
- NG-EPON IC Ad-hoc reflector archive:
http://www.ieee802.org/3/ad_hoc/ngepon/email/thrd1.html

Thank You!